



KiloVault HLX+
Lithium Iron Phosphate
Deep Cycle Solar Batteries

**INSTALLATION &
USER MANUAL**



****WARNING High Voltage Risk of Personal Injury or Death****

As is the case with all batteries, the risk of shock is present. When handling batteries, use protective measures including, but not limited to, safety glasses, insulated gloves, and protective footwear.

When working with or installing batteries, use electrically insulated gloves and tools. Remove personal metal items such as watches, rings, bracelets, etc.

The information included in this manual is accurate at the time of publication. However, this manual is subject to change without prior notice as we continuously improve our products.

Additionally, the illustrations in this manual are for demonstration only and are intended to help explain the **KiloVault® HLX+** system concepts and installation instructions. Details may vary slightly depending upon the market region and the product version.

Please note: If this unit is installed by someone other than the end-user, the installer must explain the contents of this installation and user's manual to the end-user.

PLEASE REGISTER YOUR BATTERY



Contents

1.	About the HLX+	2
1.1	Features	2
1.1.1	Battery Management System	2
1.1.2	HLX iT, the Bluetooth Monitoring Mobile Application	3
1.1.3	Heating System	3
1.2	Contact Us.....	3
2.	Safety Information.....	4
2.1	Symbols Used in This Manual	4
2.2	Warnings	4
3.	Installation.....	6
3.1	Before You Install Your Batteries	6
3.2	Location	6
3.3	Cabling.....	7
3.4	Configurations	5
4.	Operation	10
4.1	Inverter/Charger Settings.....	10
4.2	Solar Charge Controller Settings	11
4.3	Battery Monitor Settings.....	12
4.4	Generator/Automatic Generator Control Settings	13
4.5	HLX iT Bluetooth Mobile Application.....	14
4.5.1	Introduction.....	14
4.5.2	Screens & Operation.....	14
5.	Troubleshooting / Q&A.....	18
6.	Storage and Recommissioning.....	22
7.	Specifications	23
7.1	Electrical	23
7.1.1	All Models	23
7.1.2	1200 HLX+	25
7.1.3	2400 HLX+	26
7.1.4	3600 HLX+	27
7.2	Environmental	28
7.3	Physical.....	28
8.	Certifications.....	31
9.	Disposal	31
10.	Limited Warranty.....	31
10.1	Registration.....	31
10.2	Non-Transferable	31
10.3	Warranty Exclusions and Limitations.....	32

1. About the HLX+

The KiloVault® HLX+ series of solar lithium batteries are specifically designed and tested for the beating that serious hybrid, off-grid inverters, and solar charge controllers can throw at them. Compared to traditional deep cycle batteries, the HLX+ series lithium battery technology more efficiently stores and delivers the renewable energy that you have generated, with no maintenance on your part. This manual contains important information regarding the safe use of KiloVault® HLX+ series batteries. Your battery is an electrical device that will provide years of useful service with proper care. Ensure you read and understand the instructions contained in this manual before use.

1.1 Features

- 12 V Lithium Iron Phosphate (LiFeP04), a.k.a. LFP, with Bluetooth
- Models: 1200 HLX+ (100 Ah/1200 Wh), HLX+ 2400 (200 Ah/2400 Wh), and HLX+ 3600 (300Ah/3600 Wh).
- Flexible: Works in 12 Volt (V), 24 V, 36 V or 48 V configurations
- Gives You More: Use the full battery capacity if necessary. HLX+ withstands occasional 100% discharges. Please Note: frequent 100% discharges will decrease battery life.
- Long-life: Even after 2000 full discharges, 80% of the total battery capacity remains
- Maintenance Free: No watering or cleaning of hazardous chemicals required
- High Efficiency: 94.5%, providing up to 12% more usable stored energy
- Smart Investment: Lower cost per watt-hour/cycle and longer lifespan than lead batteries
- Safer: No thermal run-away issues as with other lithium technologies
- Heavy Duty:
 - The 1200 HLX+ takes up to 80 amps of continuous charging/discharging current.
 - The 2400 HLX+ takes up to 150 amps of continuous charging/discharging current.
 - The 3600 HLX+ takes up to 150 amps of continuous charging, 200 amps of continuous discharging current.
- Internal heater allows the battery to continue charging, even when the ambient temperature is below freezing.
- Integrated Battery Management System (BMS)
- HLX iT Bluetooth Monitoring Application (iOS and Android)
- 7.5 Years Limited Manufacturer's Warranty
- Push button and 4 LED display to give a rough approximation of the state of charge.

1.1.1 -Battery Management System

Every HLX+ battery contains a BMS that helps protect it from over voltage charging/discharging, over current charging/discharging, and extreme temperatures while charging and discharging. While this system is robust, batteries must be installed using appropriate inverter charge and charge controller settings, devices to protect them from open photovoltaic (PV)/solar panel voltage, and other high voltage charging sources. Failure to adhere to proper installation requirements will void the warranty and may damage the system.

1.1.2 KiloVault iT, the Bluetooth Monitoring Mobile Application

The KiloVault iT smartphone Bluetooth app enables you to view general information about the selected individual battery. It can help troubleshoot when attempting to detect the cause of the battery bank going off-line. The app is available for free download for both Android and iPhone phones. Each battery is identified by a unique name assigned at the factory.

1.1.3 Heating System

The 1200 HLX+ heater is 64 W. The 2400 HLX+ heater is 96 W, and the 3600 HLX+ heater is 192 W. The heater is powered by charging current, not by the battery. The battery does not self-discharge to warm itself.

In all of the batteries the heater starts at an internal temperature of 0°C (32°F) and stops at an internal temperature of 5°C (41°F). At external temperatures below -30°C (-22°F), the heat dissipation is too great to bring the battery up to temp.

It will take about 1.5 to 2 hours to warm the battery from an internal temperature of -20°C (-4°F) to 5°C (41°F).

When the batteries are charging with solar, it might take a longer time, depending upon the charger output.

1.2 Contact Us

Please visit our warranty registration page, <https://kilovault.com/register/>, and register your KiloVault batteries. Thank you.

If you have questions about your KiloVault battery, please contact us at:

KiloVault® LLC

330 Codman Hill Road, Boxborough, MA 01719

+1 (888) 218-5924

Info@kilovault.com

2. Safety Information

2.1 Symbols Used in This Manual



Warning:
Indicates a condition that can cause personal risk or injury.



Caution:
Indicates a condition that can cause equipment damage.



Note:
Indicates points of interest of particular emphasis that make operation more efficient or convenient.

2.2 Warnings



High Voltage Risk. Improper use may cause personal injury or death.

Do not use a battery that appears damaged in any way.

All batteries present the risk of shock, use protective measures when handling. When working with or installing batteries use electrically insulated gloves and tools. Remove personal metal items such as watches, rings, bracelets, etc.

High voltage connections of batteries (configurations of greater than 36 V DC nominal) are dangerous. DC voltages over 52 V can stop the adult human heart and a fully charged 48 V nominal system is over this level. Use appropriate safety measures including the removal of metal personal items and insulated gloves.

- A small risk of spark exists while making electrical connections.
- Ensure the installation area is free of explosive gases and liquids.
- Ensure the batteries are not installed in confined areas containing explosive substances.

This includes flammable fuel powered machinery, holding tanks, pipe fittings, and connectors. In the unlikely event of a fire, when possible, first shut off the source of electricity. Class ABC extinguishers are recommended in close proximity to your power generating equipment and are best suited for multipurpose fire types such as wood, flammable liquids, and electrical appliances.

Respiratory irritation may be caused if the battery is punctured or cracked.

Skin contact with a punctured or otherwise open battery can cause irritation.

To avoid risk of shock or fire, ensure all wires are properly sized and in good condition.

Verify all equipment to be connected to the batteries is turned off before making any electrical connections.

Do not submerge the batteries. This can cause personal injury and will void your warranty.

Do not attempt to disassemble the batteries. This can cause personal injury and will void your warranty.

KiloVault® batteries can be used in RV applications for electrical appliances ONLY. They can NOT be used to crank over motors in such vehicles.

3. Installation

3.1 Before You Install Your Batteries

1. When gathering your tools for your installation, please make sure that you have a digital multi-meter with a 0.1 V accuracy. It will help you to verify battery polarity before you make any connections. You can also use the multimeter to ensure that your batteries are at the same voltage.
2. Please write down and save the serial numbers of your batteries along with the rest of your system information. The serial numbers are on a silver barcode sticker and start with the letters "MWT". If you have already downloaded and installed the KiloVault iT battery monitoring application, also write down and save the battery names. Make sure you set aside the included terminator plugs as they can easily be misplaced.
3. Each battery must be commissioned by individually charging it to exactly 14.1 V before placing it into operation with other batteries. Otherwise, the batteries will be fully charged or fully discharged at different times and could cause a low voltage or high voltage disconnect.
 - A. You will see 14.1 V while the battery is still on the charger and actively charging. When charging is finished and the charger shuts off or the battery is disconnected, the voltage will slump to 13.3 > 13.6 V. This is normal. The battery is still fully charged.
 - B. Due to transportation regulations, lithium batteries cannot be shipped fully charged. As a result, if you have purchased more than one battery for your system all batteries must be fully charged to exactly 14.1 V before using.
 - C. Many automotive-type battery chargers will not reach 14.1 V. Please check charger specifications when selecting your charge. You can contact your KiloVault® distributor for a list of recommended chargers.
 - D. An acceptable charger:
 - Must be a 12 V charger.
 - Maximum charge voltage - 14.1 V.
 - Must have Equalization disabled.
 - 1200 HLX+ maximum charge amperage - 80 A.
 - 2400 HLX+ maximum charge amperage - 150A.
 - 3600 HLX+ maximum charge amperage - 150A.
 - Charger must taper the amps as the battery approaches 14.1 V.
 - E. After batteries are fully charged and disconnected from the charger, allow them to rest for a minimum of two hours. During this time, the voltage will relax, even as low as 13.3 V. Your batteries are still fully charged. This is normal.

3.2 Location

Locate your battery bank in a place that is dry and as well protected from extreme temperatures as possible. No ventilation is required as these do not off-gas like lead-acid batteries do.

HLX+ batteries must be placed flat on their bottoms. Any other orientation will void the warranty. Also, do not stack them one directly on top of another.

Batteries warm up while in use. Please consider your local average and seasonal temperature when positioning your battery bank. If they will be in a warmer environment, you may want to leave a minimum of one inch spacing between each of the batteries.

If they will be subjected to cold temperatures, you may want to place them as closely as possible to each other. Consider adding insulation or an insulated enclosure around the batteries if they will be exposed to temperatures that approach 32°F (0°C). The BMS will not allow charging when the internal temperature is below freezing, and they will try to warm themselves using the charging current. Using insulation when it is cold will maintain more of the heat generated during normal charging and reduce the chance of the BMS shutting the battery down to protect the battery cells.

Please note battery capacity is reduced by 20% as its internal temperature falls between room temperature (approximately 77°F (25°C) and just above 32°F (0°C).

Please remember to remove the insulation in warmer months. Overheating the batteries will shorten their life and the BMS will shut down the battery in temperatures above 149°F (65°C).

3.3 Cabling

All wire must be the appropriate gauge and construction to handle the loads that will be placed upon it. Heavy gauge, fine stranded copper wire is the industry standard. A minimum of 2/0 or 4/0 AWG copper cable is recommended for battery interconnect cables.

The cables connecting batteries in series into rows must be the same length. The cables connecting the rows in parallel must be the same length. The home run cables to the inverter must be the same length. Cables of different lengths will cause voltage differences in your battery bank. The rows in your battery bank must be kept within 0.2 V of each other to ensure that they work correctly and that large currents between rows aren't generated.

If your battery bank suddenly shuts down as one or more rows approaches fully charged or fully discharged, it is likely either the batteries are not all at the same state of charge or, if they are measured with a multimeter to be all the same voltage, the voltage drop across the cables connecting the rows is not equal. Also use the voltmeter to make sure that the voltage drops across each battery interconnect is very close.

Torque all bolts and battery terminals to between 7.38 and 8.11 ft-lbs (88.51 to 97.36 in-lbs OR 10 to 11 nm). Terminals left insufficiently tightened will lead to overheating, melting the battery terminals and potentially causing a fire. Be careful when using thin washers. You may think you're applying sufficient torque, but if the washers are too thin, the cable lugs can still move. Add additional washers until you can tighten, and the cable lugs cannot move.

3.4 Configurations

The KiloVault® HLX+ series of batteries can be used in 12 V, 24 V, 36 V, and 48 V configurations where one, two, three or four batteries are connected in series, plus to minus, in a row., 4 in parallel strings or 4 batteries in series. Each of the batteries must be kept within 0.2 V of each other or the battery bank may prematurely shut down during charging and discharging. There are configuration limitations depending on the temperature range of the installation location.

4. - Operation

It is very important that your battery chargers (solar charge controller, inverter/charger or AC) can be set to settings appropriate for the HLX+. If it cannot, please contact KiloVault Technical Support for guidance. Adjust your settings as necessary until your system performance best fits your power use patterns and needs.

Also, some chargers just have settings for broad battery types like; flooded, gel, agm or lithium. Before using these chargers on your battery, please contact KiloVault technical support for guidance.

Note: If you cannot find a specific setting, remember to check the settings for guidance. Also, please don't hesitate to contact KiloVault technical support for help.

4.1 Inverter/Charger Settings

Setting	Values: Volts are per HLX+ in a single string. Amps are per parallel string.
1200 - Battery Capacity	1200 Wh, 100 Ah
2400 - Battery Capacity	2400 Wh, 150 Ah
3600 - Battery Capacity	3600 Wh, 300 Ah
1200 - Max Charge Current	80 A
2400 - Max Charge Current	150 A
3600 - Max Charge Current	200 A
Absorb End Amps	2 A
Absorb Time (some controllers do not allow a selection under 6 minutes, please contact KiloVault for additional information)	2 minutes or less
Absorb Voltage	14.1 V
Battery Temperature Compensation	0 mV/°C
Battery Type	Lithium or Custom, whichever lets you set the recommended settings
Bulk Voltage	14.1 V
Charge Cycle	2 stage no float
Default Battery Temperature	Warm

Equalization	Disabled
Float Voltage	13.4 - Normally the inverter/charger is set to 2-Stage-No-Float, but if it has to be set then used this value
HBCO (High Battery Cut Out)	14.4 V
LBCO (Low Battery Cut Out)	12.25 V (or as close as it can be set)
LBCO Delay	5 seconds
LBCO Hysteresis	0.5 V
Max Bulk Current	Set the inverter max bulk current so that when it is added to the charge controller current, together they add up to less than the max charge current for your battery bank.
Peukert Factor	1.05
Recharge/Re-Bulk Volts (\approx 80% DoD)	12.75 V
1200 - Recommended Charge Current	50 A or less per HLX in Parallel
2400 - Recommended Charge Current	100 A or less per HLX in Parallel
3600 - Recommended Charge Current	200 A or less per HLX+ in Parallel

4.2 Solar Charge Controller Settings

Setting	Values: Volts are per battery in a single string. Amps are per string in parallel
1200 - Battery Capacity	1200 Wh, 100 Ah
2400 - Battery Capacity	2400 Wh, 200 Ah
3600 - Battery Capacity	3600 Wh, 300 Ah
Absorb Time	2 minutes or less
Absorb Voltage	14.1 V
Battery Temperature Compensation	Do not use a battery temperature sensor with these batteries! If the sensor or compensation value is required for a charge controller or inverter charger to work, set the battery temperature compensation to 0mV/°C
Battery Temperature Compensation	0.00 mV/deg C

Battery Type	Lithium or Custom, whichever lets you set the recommended settings
Battery Voltage - Nominal	12 V
Bulk Termination Voltage (if applicable)	13.9 V
Bulk Voltage	14.1 V
Charge Cycle	3 stage
Equalization	Disabled
Float Voltage (set below the resting voltage of the battery bank)	≈13.4 V or lower. Low enough to not trigger float when the battery "relaxes" after charging stops.
Max Float Current	10 A
Maximum Charge Rate - 1200	80 A, C/1.25
Maximum Charge Rate - 2400	150 A, C/1.3
Maximum Charge Rate - 3600	200 A, C/1.5
Recharge Volts (≈80% DoD)	Just above your inverter/charger recharge/rebulk volts so it starts charging from the sun before the inverter starts charging from the grid or generator.

4.3 Battery Monitor Settings

Setting	Values: Volts are per battery in a single string. Amps are per string in parallel
1200 Battery Capacity	1200 Wh, 100 Ah
1200 C-Rating	C/1.25
2400 Battery Capacity	2400 Wh, 200 Ah
2400 C-Rating	C/1.3
3600 Battery Capacity	3600 Wh, 300 Ah
3600 C-Rating	C/1.5
Battery Efficiency	94.50%

Charge Ending Amps	2 A
Charger Float Current - 1200 - 1% of capacity	1 A
Charger Float Current - 2400 - 1% of capacity	2 A
Charger Float Current - 3600 - 1% of capacity	3 A
Charger Float Voltage	≈13.4 V
Fully Charged Voltage	14.1 V
Nominal Temperature	77°F (25°C)
Peukert's Exponent	1.05
Recharge / Re-Bulk Volts (≈80% DoD)	12.75 V
Self Discharge Rate	≤2% per month
Temperature Coefficient	0 mV / °C
Battery Temperature Sensor	Do not use a battery temperature sensor with these batteries!

4.4 Generator/Automatic Generator Control Settings

The battery related settings for using a generator and/or an automatic generator start/stop (AGS) control with HLX+ batteries can usually be found in the inverter/charger and solar charge controller settings.

Some generators and/or AGS have settings for 2 minute, 2 hour and 24 hours (or similar duration) start voltages. They set time limits the battery voltage can sit at before activating the generator. They are related to the Low Voltage Disconnect/Cut-Off voltage and the Recharge/Re-bulk voltage. Expect to adjust any or all of them over time to get exactly the generator behavior you wish. Depending on the make and model of the generator or AGS, you may need to have more spacing between these settings.

- 2 minutes - Set just above the inverter/charger Low Voltage Disconnect (12.25 V) so the generator starts before the inverter stops inverting.
 - Start at approx. 12.3 V and adjust as necessary.
- 2 hours - Set above the 2 minutes volts.
 - Start at approx. 12.4V.
- 24 hours - Set just below the Recharge/Re-bulk voltage. If the Recharge/Re-bulk setting hasn't already started the generator at this time, the generator will start.
 - Start at approx. 12.7 V if Recharge/Rebulk is 12.75 V.

4.5 HLX iT Bluetooth Mobile Application

4.5.1 Introduction



Disclaimer:

The KiloVault® Bluetooth® mobile application is provided as is and is solely intended to gather general information. It is not intended to replace a voltmeter, ammeter, or any other testing / measurement device. Nor is it guaranteed to work with every mobile device.

The KiloVault® HLX iT smartphone Bluetooth® app enables you to view general information about the selected individual battery. It can help troubleshoot when attempting to detect the cause of the battery bank going off-line. The app is available as a free download for both *Android* and *iOS* devices on the *iOS* and *Google Play* app stores.

Your Android / iOS mobile device must support Bluetooth® 4.0 and Bluetooth® Low Energy (BLE). The iOS version requires iOS 10.0 or later and is compatible with iPhone, iPad, and iPod touch. The Android version requires Android 4.3 (Jelly Bean) and up. Additionally, the Android version must have permission to access both Location and Local Storage.

4.5.2 Screens & Operation

When you first start HLX iT, if you have Bluetooth enabled, the screen will show all of the HLX batteries within a 30m radius, depending on the physical or electrical interference.

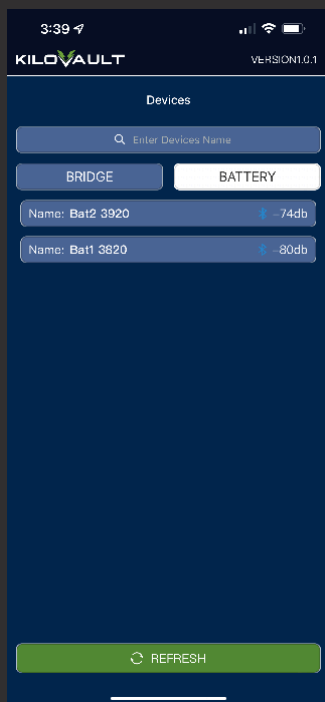

DEVICE SCREEN

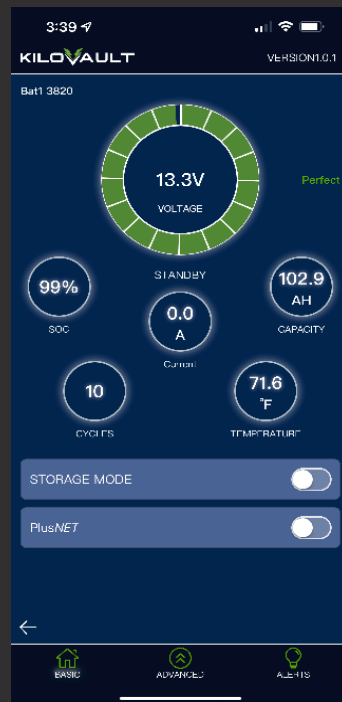

BASIC INFORMATION



CLOSEUP-TABS

Tap on any of the batteries shown on the Device screen. The Basic information screen will load, along with 4 menu tabs or buttons or icons at the top of the screen.

The *Basic Information* screen shows the voltage, state of charge, capacity, status (charging / discharging / standby), and health of that battery. The state of charge (**SoC**) is an estimated value and does not drive any battery behaviors / performance. To get back to your list of batteries, tap the arrow in the lower left corner of the screen.

From the Basic screen you can also get detailed information on battery current alarms, individual battery cells and if you wish, rename your batteries.

There can be as much as 0.3 V difference between the volts shown in the app and the volts measured at the terminals, especially in the middle of a charge / discharge cycle. At the beginning and end of the voltage range, the values converge.

To get information on individual cells, first select the “ADVANCE” tab in the lower portion of the Battery’s Information screen. A login dialog will appear. Type “1234” into the login dialog and tap “confirm”. A button called “Battery Information” will appear. Tap that button. A semi-transparent screen will appear with 8 button-like icons. They indicate if the battery has any active alarms. The indicators are normally green. They will be red if there is an alarm. They are High Voltage (HV), Low Voltage (LV), Overcurrent Charging (OCC), Overcurrent Discharging (OCD), Low Temperature Discharging (LTD), Low Temperature Charging (LTC), High Temperature Discharging (HTD), High Temperature Charging (HTC).

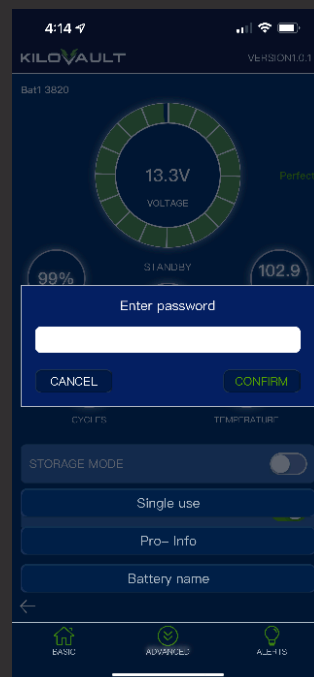

PASSWORD SCREEN

Below the alarm indicators are 4 battery shaped icons. They represent the 4 cells that make up the battery. Their color does not indicate anything. They are always the same color. Below each battery icon is a number showing each cell’s voltage in mV (millivolts). The color of the numbers do not mean anything. They’re always the same color. The difference between the highest and lowest should be 300mV or less. Tap anywhere to dismiss this screen.



Battery Details Screen

To rename your batteries, first write down the original battery name, the battery serial number, and store this information in a safe place. Then select the “ADVANCE” tab in the lower middle of the Battery’s Information screen. A login dialog will appear. Type “5678” into the login dialog and tap “confirm”. A dialog box “Edit Device” will appear. Type in the new name and tap “Confirm”. The battery is now renamed.

Tap the light bulb shaped tab (the third from the left) at the bottom of the screen, to get to the alerts screen. Here you’ll find any active Events on the HLX+. Events are not saved into any kind of history.

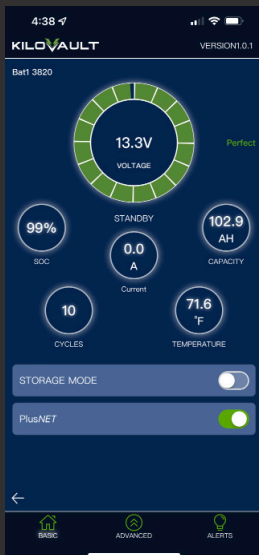

ADVANCED TAB

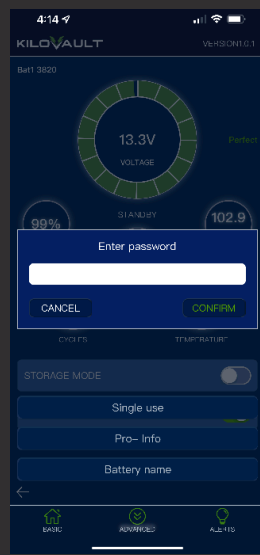

PASSWORD SCREEN

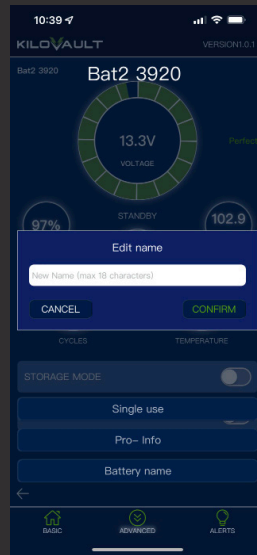

EDIT NAME SCREEN



ALERTS SCREEN

5. Troubleshooting / Q&A

1. Why is the battery bank suddenly shutting off?

- Likely, one or more of your batteries are not at the same voltage as the others. Those batteries are hitting the upper or lower voltage cutoffs ahead of the others. When those batteries shut themselves off to protect themselves, the battery bank drops below the operating voltage of the inverter. Check all of the battery connections. Charge each battery up to 14.1 V. If the problem persists, please contact KiloVault.
- Your loads (DC load or inverter) have exceeded the current capacity of the battery bank. The 1200 HLX+ maximum continuous discharge current is 80 A per 1200 in parallel. The 2400 HLX+ maximum continuous discharge current is 150 A per 2400 in parallel. The 3600 HLX+ maximum continuous discharge current is 200 A per 3600 in parallel. If your known loads are close to your battery bank's max continuous discharge current or if you have very high surge loads like pumps or HVAC systems, your loads may simply be too high for your bank. Please contact KiloVault about adding an additional parallel row of KiloVault batteries to your bank.

2. Why aren't the battery voltages staying equal over time?

- The battery cables are not of equal length or are damaged. Check to make sure that all battery interconnects are of equal length, gauge and are in good condition.
- Cable terminal hardware is not tightened properly. Check to make sure that all terminal hardware is tightened to between 7.38 and 8.11 ft-lbs (88.51 to 97.36 in-lbs OR 10 to 11 nm). Check to make sure all of the crimps on all cables are tight and solid. Use the Ohms (Ω) setting on a voltmeter to measure the resistance of the battery interconnect cables. They should all be within 0.1 ohms of each other.

3. Why has the battery reversed polarity?

- Verify the voltmeter probe orientation.
- The battery has dropped into the low voltage protection range and the BMS has shut down the battery. If so, you can wait for the battery to reset or you can connect the battery to a 14.1V charge.

4. Why is the battery turning off and off when it is connected to a small DC device or inverter?

- HLX+ batteries have an automatic standby mode where they will shut themselves down if they do not see a load of more than 200-250 mA. That is about 3 Watts per series battery (i.e., 3 watts for a single 12 V battery, 6 watts for 24 V series, and 12 watts for 48 V). In the standby mode the battery turns back on about every 15-20 seconds to search and see if there is load connected to it. If your load is not larger than this minimum current then the battery will not stay on.
- Consider connecting an additional small DC load to the batteries to increase the current draw to over 250 mA. If you are using an inverter, it is possible that it is going into its own standby mode and it is consuming less than the minimum current required to keep the batteries on. Also, for this case of the inverter, consider adding another small additional DC load to increase the current draw to over 250 mA.

5. Can an HLX+ battery be charged with an auto / RV alternator?

- Yes, as long as the alternator provides the appropriate charging current for your battery and does not exceed 14.1 V.

6. What is the terminal mounting hardware size?

- M8 - 1.25 x 16 mm bolts. In all models, the terminals extend 1 mm above the case.

7. What are the recommended voltage settings for a generator?

- We recommend a low-voltage start of 12.3V and a cut-off voltage of 13.9V (multiply those numbers by 2 for 24V and 4 for 48V systems). Please see the Generator/Automatic Generator Start settings in section 4.

8. What voltage settings are recommended for an 80% depth of discharge?

- We recommend a Recharge / Re-Bulk voltage of 12.75 V per HLX+ in series for an 80% Depth of Discharge.

9. Is there a special mobile application to connect to the batteries via Bluetooth?

- HAB iT, the KiloVault® mobile Bluetooth application, enables you to view general information about the selected individual battery. It can help troubleshoot when attempting to detect the cause of the battery bank going off-line. The app is available as a free download for both Android and iOS devices on the iOS and Google Play app stores.

- Your Android / iOS mobile device must support Bluetooth® 4.0 and Bluetooth® Low Energy (BLE). The iOS version requires iOS 10.0 or later and is compatible with iPhone, iPad, and iPod touch. The Android version requires Android 4.3 (Jelly Bean) and up. Additionally, the Android version must have permission to access both Location and Local Storage.
- Please note that the app is provided “as is” to serve as a free troubleshooting tool. Also, please be aware that a good voltmeter provides a more accurate voltage reading than the Bluetooth application.

10. Is there a desktop or Wi-Fi application to connect to the batteries?

- No, there isn't a Wi-Fi application for the HLX+, and there isn't a desktop application for the HLX+

11. What do I do if my inverter does not have an AC charger?

- Use a 12 V AC charger (capable of charging up to 14.1 V) connected to a generator or the utility company's power to charge each battery. We recommend the Iota Engineering DLS series of 12 V AC Chargers that are capable of being configured for this slightly higher voltage.
- Use a 12 V solar charge controller (set to 14.1 V or 'sealed battery' charging, as long as it gets to 14.1 V) with a solar panel to charge up the batteries individually. This method will take longer than an AC charger unless you are using a high amperage charge controller with sufficient solar panels.

12. Why is the battery turning on and off when it is connected to a simple battery monitor?

- The HLX+ needs at least a 250mA load or they will go into their power saving, standby mode. The simplest solution is to connect additional loads to reach at least 250mA (3 Watts).

13. Why does the battery voltage momentarily drop when a load is initially connected?

- This is the normal result of the battery switching from its pre-charge function to providing enough current to devices that have input capacitors and draw high current surges in an extremely short period of time. The battery will resume its normal voltage within a few seconds.

14. Why isn't the battery working when it is connected to the inverter?

- Some inverters have higher input capacitors whose current draw overwhelms the pre-charge function of the HLX+. To minimize the initial draw when the batteries are initially connected to the inverter, make sure that the inverter is off while connecting. Then wait at least 45 seconds before powering up the inverter.

15. Why does the HLX iT show short circuit events in the log?

- When the battery is connected to a DC load or a charging current the pre-charging function of the battery is enabled. That pre-charging function is used to compensate for the surge capacitors on the input side of inverters and other devices. The order of connecting devices may trigger the short circuit protection in the BMS once the high inrush device (usually an inverter) is connected. The solution here is to disconnect all devices from the battery (even battery monitors), first connect the inverter, wait 45 seconds and then connect the remaining devices.

16. Do high temperatures affect how the batteries perform?

- Yes, the battery cycle life will be reduced if they are regularly charged and discharged above ambient temperatures of 100 degrees F. Please see the environmental specifications.

17. Do low temperatures affect how the batteries perform?

- At 0°C (32°F), if there is a charging current, the HLX+ will try and warm themselves up to 5°C (41°F).
- Please note battery capacity is reduced by 20% as its internal temperature falls between room
- Temperature (approximately 77°F (25°C)) and just above 32°F (0°C).

18. Why is the voltage shown in HLX iT not the same as what is measured at the terminals?

- The gap between the volts shown in HLX iT and the volts measured at the terminals can be as large as 0.3 V, especially near the middle of a charge / discharge cycle. The gap closes at the beginning and end of a cycle.

19. Why does HLX iT show my battery at 100% SoC when the battery voltage hasn't reached 14.1 V? Why are my batteries showing different States of Charge (SoC) even though they are at the same voltage?

- The HLX+ SoC needs to be re-calibrated. Please try re-calibrating the battery SoC by doing the Re-Commissioning process:
 - Charging the HLX all the way up to 14.1 V. If the SoC reaches 100% before the battery is at 14.1 V, please do not stop charging. Keep charging all of the way to 14.1 V.
 - Then Discharge the HLX all of the way to 12V.
 - Then re-charge the HLX normally, once again up to 14.1V.
 - The SoC should now be re-calibrated.

Remember, the SoC reported in the app is an approximation for people to use, but the battery behavior is actually driven by the Volts and Amps.

20. My HLX+ is stuck in a protection mode. The voltage measured at the battery terminals is in the single digits and it does not show up in the HLX iT app. How do I wake it up?

- Press the HLX+ reset button for 5 seconds.

6. Storage and Recommissioning

For long term storage (i.e., 6 months or more) simply disconnect all sources of charge and discharging from the battery bank.

Although the batteries have a very low self-discharge rate ($\leq 2\%$ /month, $\leq 12\%$ /year) they should be charged a minimum of every six months. Connecting a trickle charger is not recommended, unless the charger can be configured to stop charging at 14.2V or below. Most trickle chargers are not smart enough to provide this charge voltage ability. Over-charging the battery triggers the over-charge protection which shuts the battery down until the voltage goes down enough by itself. Once that happens the trickle charger would quickly raise the voltage up too high once again. As a result, the constant cycling of this circuitry will shorten the life of the entire battery.

Recommended Storage Temperature and Humidity:

- 15°C to 35°C, 45% to 75% Relative Humidity.
- They can be stored at 4°F to 113°F (-20°C to 45°C), 45% to 75% Relative Humidity for 1 month or less.
- They can be stored at 14°F to 95°F (-10°C to 35°C), 45% to 75 Relative Humidity for 3 months or less.

Re-commissioning your HLX+ batteries is the same as commissioning them. Charge each battery up to 14.1 V. Once the battery reaches the 5C / 41F, then the battery will start charging.

If the ambient temperature is below 39°F (4°C), reduce the initial charge current to no greater than 30A for the 1200, 60 A for the 2400, and 90A for the 3600 until the batteries have had a chance to warm up. If the temperature is below 32°F (0°C), instead of charging, the heater will activate and warm the battery to an internal temperature of 5°C (41°F).

7. Specifications

These are HLX+ specifications not settings. Please see the Operation section for charger and other equipment settings.

7.1 Electrical All Models

Specification	Value
BMS Type	Switching Shunt Resistor
Efficiency	94.50%
Estimated number of cycles at 100% DoD until 80% of rated watt hour capacity remains	2000
Estimated number of cycles at 80% DoD until 80% of rated watt hour capacity remains	5000
High Voltage (Overcharge) Shutoff Protection	$\approx 15 \pm 0.12 \text{ V}$ ($3.75 \pm 0.03 \text{ V / cell}$)
High Voltage Shutoff Release	Discharge below $\approx 14.4 \pm 0.2 \text{ V}$ ($3.60 \pm 0.05 \text{ V / cell}$)
Low Voltage (Over-discharge) Shutoff Protection	$\approx 10.2 \pm 0.2 \text{ V}$ ($2.50 \pm 0.05 \text{ V / cell}$)
Low Voltage Shutoff Release	Charge above $11.2 \text{ V} \pm 0.4 \text{ V}$ ($2.80 \pm 0.10 \text{ V / cell}$)
Maximum Configuration - Temperature falls below freezing	Up to 4 batteries in series OR 4 batteries in parallel but not both. Total of 4 batteries.
Maximum Time Between Charges	6 Months
Minimum Cell Balancing Voltage	3500 mV/Cell
Normal Self-Discharge Current	$\leq 20 \text{ mA}$
Peukert Coefficient	1.05
Rated Voltage	12.8 VDC
Recommended Charge Voltage	14.1 V
Recommended Float Voltage	13.4 V

Self-Discharge Rate	≤2% per month
Standby Mode Activated	Current Draw from Load < 0.25 A (250 mA)
Voltage Configurations	12 V, 24 V, 36 V, 48 V
High Temperature Protection Trigger	≈149° (65°C)
High Temperature Protection Release	≈122°F (50°C)
Low Temperature Protection Trigger	≈32°F (0°C)
Low Temperature Protection Release	≈41°F (5°C)
Heater Behavior	The heater starts at an internal temperature of ≈32°F (0°C) and stops at an internal temperature of ≈41°F (5°C)

Charge / Discharge Curve

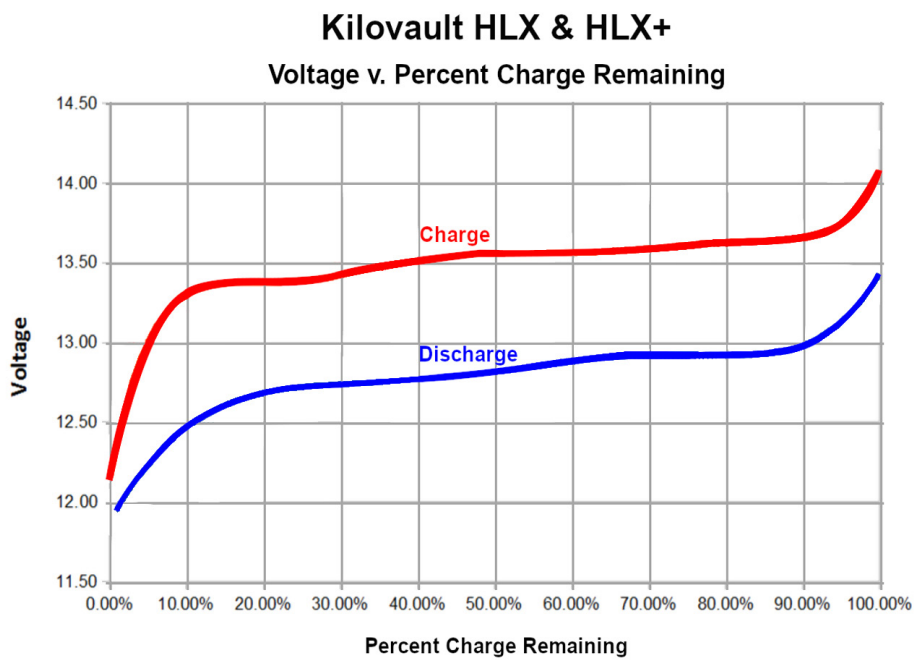

7.1.2 1200 HLX+

Specification	Value
Heater	64 W
Internal Resistance	$\leq 10\text{m}\Omega$
Maximum Continuous Charge Current	80 A
Maximum Continuous Discharge Current	80 A
Overcharge (High Voltage) Protection Release Method	Discharge below $\approx 14.4 \pm 0.2\text{ V}$ ($3.60 \pm 0.05\text{ V / cell}$)
Overcharge Protection Trigger Voltage	$\approx 15 \pm 0.12\text{ V}$ ($3.75 \pm 0.03\text{ V / cell}$)
Over-discharge (Low Voltage) Protection Release Method	Charge above $11.2\text{V} \pm 0.4\text{ V}$ ($2.80 \pm 0.10\text{ V / cell}$)
Over-discharge Protection Trigger Voltage	$\approx 10.2 \pm 0.2\text{ V}$ ($2.50 \pm 0.05\text{ V / cell}$)
Overcurrent Protection - Time delay until high charge current triggers protection @ $110 \pm 5\text{ A}$	$\approx 25\text{ Seconds}$
Overcurrent Protection - Time delay until high charge current triggers protection @ $150 \pm 5\text{ A}$	$\approx 3\text{ Seconds}$
Overcurrent Protection - Time delay until high discharge current triggers protection @ $110 \pm 5\text{ A}$	$\approx 25\text{ Seconds}$
Overcurrent Protection - Time delay until high discharge current triggers protection @ $300 \pm 20\text{ A}$	$\approx 3.5\text{ Seconds}$
Overcurrent Protection (Charging) Release Method	Discharge battery for immediate release. Wait 1 minute for auto-release.
Overcurrent Protection (Discharging) Release Method	Charge battery for immediate release. Wait 1 minute for auto-release.
Peak or Surge Discharge Current	350 A for less than 3 seconds
Rated Capacity	100 Ah
Recommended Charge Current	$\leq 50\text{ A}$

7.1.3 2400 HLX+

Specification	Value
Heater	120 W
Internal Resistance	$\leq 20\text{m}\Omega$
Maximum Continuous Charge Current	150 A
Maximum Continuous Discharge Current	150 A
Overcharge Protection Release Method	Discharge below $\approx 14.4 \pm 0.2 \text{ V}$ ($3.60 \pm 0.05 \text{ V / cell}$)
Overcharge Protection Trigger Voltage	$\approx 15 \pm 0.12 \text{ V}$ ($3.75 \pm 0.03 \text{ V / cell}$)
Over-discharge Protection Release Method	Charge above $11.2\text{V} \pm 0.4 \text{ V}$ ($2.80 \pm 0.10 \text{ V / cell}$)
Over-discharge Protection Trigger Voltage	$\approx 10.2 \pm 0.2 \text{ V}$ ($2.50 \pm 0.05 \text{ V / cell}$)
Overcurrent Protection - Time delay until high charge current triggers protection @ $210 \pm 5 \text{ A}$	$\approx 25 \text{ Seconds}$
Overcurrent Protection - Time delay until high discharge triggers protection @ $210 \pm 5 \text{ A}$	$\approx 20 \text{ Seconds}$
Overcurrent Protection - Time delay until high discharge triggers protection @ $400 \pm 20 \text{ A}$	$\approx 3.5 \text{ Seconds}$
Overcurrent Protection (Charging) Release Method	Discharge battery for immediate release. Wait 1 minute for auto-release.
Overcurrent Protection (Discharging) Release Method	Charge battery for immediate release. Wait 1 minute for auto-release.
Peak or Surge Discharge Current	500 A, less than 3 second
Rated Capacity	200 Ah
Recommended Charge Current	$\leq 100 \text{ A}$

7.1.4 3600 HLX+

Specification	Value
Heater	192 W
Internal Resistance	$\leq 20\text{m}\Omega$
Maximum Continuous Charge Current	150 A
Maximum Continuous Discharge Current	200 A
Overcharge Protection Release Method	Discharge below $\approx 14.4 \pm 0.2 \text{ V}$ ($3.60 \pm 0.05 \text{ V / cell}$)
Overcharge Protection Trigger Voltage	$\approx 15 \pm 0.12 \text{ V}$ ($3.75 \pm 0.03 \text{ V / cell}$)
Overdischarge Protection Release Method	Charge above $11.2\text{V} \pm 0.4 \text{ V}$ ($2.80 \pm 0.10 \text{ V / cell}$)
Overdischarge Protection Trigger Voltage	$\approx 10.2 \pm 0.2 \text{ V}$ ($2.50 \pm 0.05 \text{ V / cell}$)
Overcurrent Protection - Time delay until high charge current triggers protection @ $210 \pm 5 \text{ A}$	$\approx 25 \text{ Seconds}$
Overcurrent Protection - Time delay until high discharge triggers protection @ $210 \pm 5 \text{ A}$	$\approx 20 \text{ Seconds}$
Overcurrent Protection - Time delay until high discharge triggers protection @ $400 \pm 20 \text{ A}$	$\approx 3.5 \text{ Seconds}$
Overcurrent Protection (Charging) Release Method	Discharge battery for immediate release. Wait 1 minute for auto-release.
Overcurrent Protection (Discharging) Release Method	Charge battery for immediate release. Wait 1 minute for auto-release.
Peak or Surge Discharge Current	500 A, less than 3 seconds
Rated Capacity	300 Ah
Recommended Charge Current	$\leq 150 \text{ A}$

7.2 Environmental

Specification	Value
Ambient Temperature Range	-4°F to 113°F (-20° C to 45°C)
Optimal Internal Temperature Range	59°F – 95°F (15 – 35°C)
Internal Temperature Range - Charging	32°F to 113°F (0°C to 45°C)
Internal Temperature Range - Discharging	-4°F to 131°F (-20°C to 55°C)
High Internal Temperature Charge Protection	149°F (65°C) with protection release at 122°F (50°C)
High Internal Temperature Discharge Protection	149°F (65°C) with protection release at 122°F (50°C)
Low Internal Temperature Charge Protection	32°F (0°C) with protection release at 39°F (4°C)
Low Internal Temperature Discharge Protection	-4°F (-20°C) with protection release at 14°F (-10°C)
Ingress Protection - Water Please see section 8, Certifications	Splashing Water: Water splashing against the enclosure from any direction shall have no harmful effect.
Maximum Altitude	3000 meters
Recommended Humidity	45% to 75%

7.3 Physical

Specification	Value
1200 HLX+ Height	9.25 ± 0.08 in (235 ± 2 mm)
1200 HLX+ Width	6.5 ± 0.08 in (165 ± 2 mm)
1200 HLX+ Length	12.52 ± 0.08 in (318 ± 2 mm)
1200 HLX+ Weight	25.8 lb (11.7 kg)
2400 HLX+ Height	10.04 ± 0.08 in (255.2 ± 2 mm)
2400 HLX+ Width	6.8 ± 0.08 in (172.5 ± 2 mm)

2400 HLX+ Length	19.8 ± 0.08 in (505 ± 2 mm)
2400 HLX+ Weight	59.5 lb (27 kg)
3600 HLX+ Height	9.25 ± .04 in (235 ± 1mm)
3600 HLX+ Width	11.02 in (280 mm)
3600 HLX+ Length	20.5 in (520 mm)
3600 HLX+ Weight	88.2 lb (40 kg)
Terminals	Stainless Steel M8 - 1.25 x 16 mm Bolts. In all models, the terminals extend 1mm above the case.
Terminal torque	Tighten the terminal bolts to between 7.38 and 8.11 ft-lbs (88.51 to 97.36 in-lbs OR 10 to 11 nm)

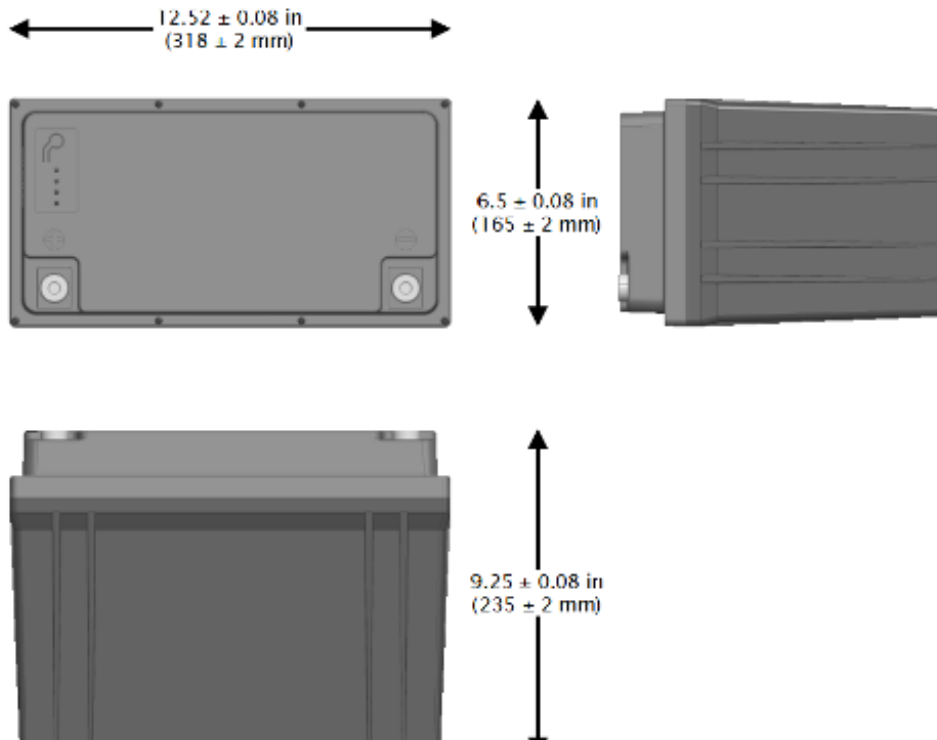

1200 HLX+ Dimensions

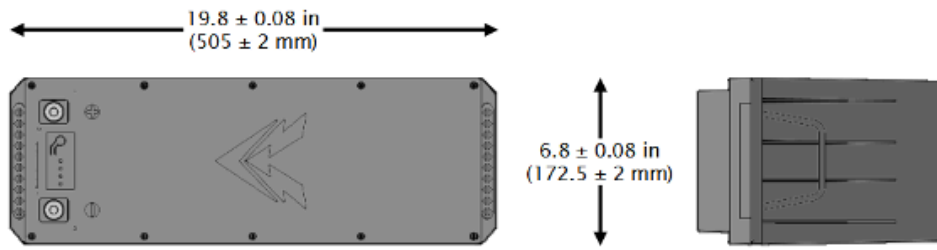

2400 HLX+ Dimensions

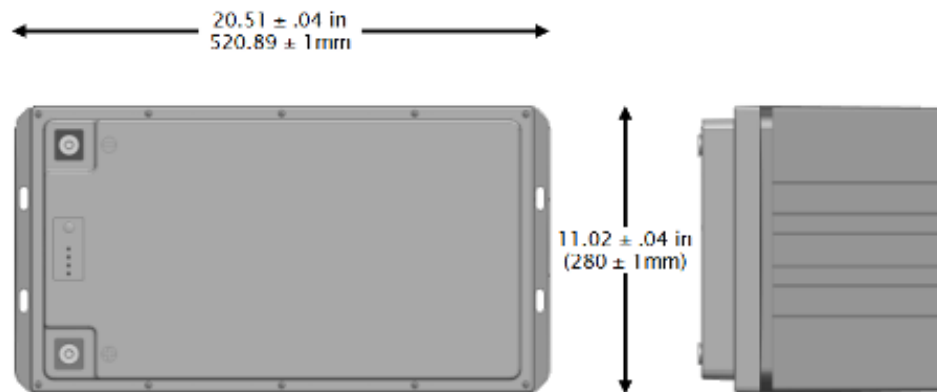

3600 HLX+ Dimensions

8. Certifications

- cETLus
- UN DOT 38.3 (acceleration 3 times each side)
 - 50 gn for 11 ms
 - 150 gn for 6 ms
- Ingress Protection Rating: IPX4 (applies only with the network connection cover securely in place)

9. Disposal

- Do not incinerate.
- Please recycle in accordance with local laws and disposal services.

10. Limited Warranty

Model	Free Replacement or Repair Period (months)	Prorated Credit Period (months)	Total Warranty Period (years)
HLX+ 1200	36	54	7.5
HLX+ 2400	36	54	7.5
HLX+ 3600	36	54	7.5

10.1 Registration

Failing to register on time and with accurate information can void the warranty.

Please register your HLX+ batteries at: <https://kilovault.com/register/>.

10.2 Non-Transferable

This Limited Warranty is to the original purchaser of the Product and is not transferable to any other person or entity. Please contact the place of purchase regarding any warranty claim.

10.3 Warranty Exclusions and Limitations

The Manufacturer has no obligation under this Limited Warranty for Product subjected to the following conditions (*including but not limited to*):

- Damage caused during shipping or mishandling of the Product
- Damage due to improper installation; loose terminal connections, under-sized cabling, interconnect cables of non-equal lengths/voltage drops, incorrect connections (series and parallel) for desired voltage and amp-hour requirements, reverse polarity connections or insufficient space for airflow
- Environmental damage, inappropriate storage conditions as defined by the Manufacturer; exposure to extreme hot or cold temperatures, fire or freezing, or water damage
- Damage caused during operation; by collision, over-charging or over-discharging the Product as defined by the Manufacturer
- Damage caused by lightning, fire, water or Acts of God
- Damage due to improper maintenance; under- or over-charging the Product, lack of cleaning resulting in corroded terminal connections or build-up of dirt, debris, organic matter, fossil fuels or chemicals on the Product casing
- Product that has been opened, modified or tampered with

Please see <https://kilovault.com/kilovault-hlx-series/> for the complete provisions of the warranty.





INSTALLATION & USER MANUAL

KiloVault* LLC
330 Codman Hill Road
Boxborough, MA 01719
+1(888)218-5924
info@kilovault.com
www.kilovault.com